

The Antikythera mechanism  
*μηχανισμός των Αντικυθέρων*

Przemysław Jacewicz

11 April 2011

# THE ANTIKYTHERA WRECK



# THE ANTIKYTHERA WRECK TREASURES

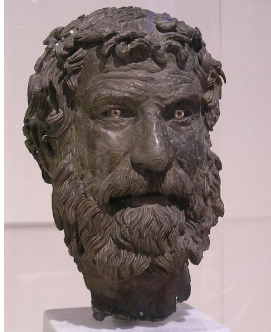

# THE ANTIKYTHERA WRECK



1. discovered on 17th May 1902
2. more than 80 pieces, with 3 big ones
3. gears and gear teeth clearly visible

# THE ANTIKYTHERA MECHANISM NOW



National Archaeological Museum of Athens (2010) – copyright prof. Sołtan



# THE ANTIKYTHERA MECHANISM NOW



National Archaeological Museum of Athens (2010) – copyright prof. Sołtan



# BRIEF MODERN HISTORY

## 1. **DEREK J. DE SOLLA PRICE** with Charalampos Karakalos (both physicists);

- first scientific investigations in 1950's – using X and  $\gamma$  rays
- 1974 – first full description
- built a replica of the mechanism

## 2. **MICHAEL WRIGHT**

- X-ray tomography
- significant new discoveries
- also built a replica

## 3. **THE ANTIKYTHERA MECHANISM RESEARCH PROJECT**

- Cardiff University + National and Kapodistrian University of Athens + Aristotle University of Thessaloniki + X-Tek System UK + HP USA
- 3-D surface imaging + tomography
- new discoveries – more than 1000 new letters found



# THE ANTIKYTHERA MECHANISM ANALYSIS

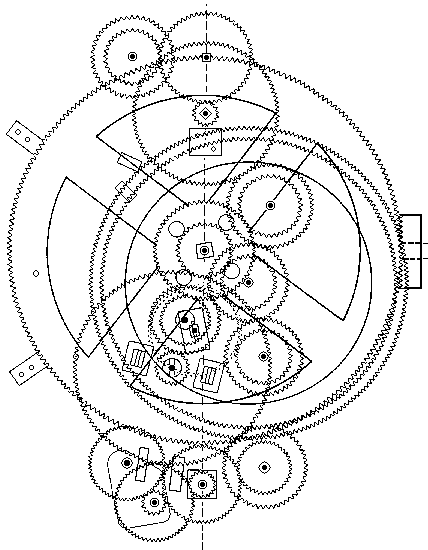

# THE ANTIKYTHERA MECHANISM ANALYSIS

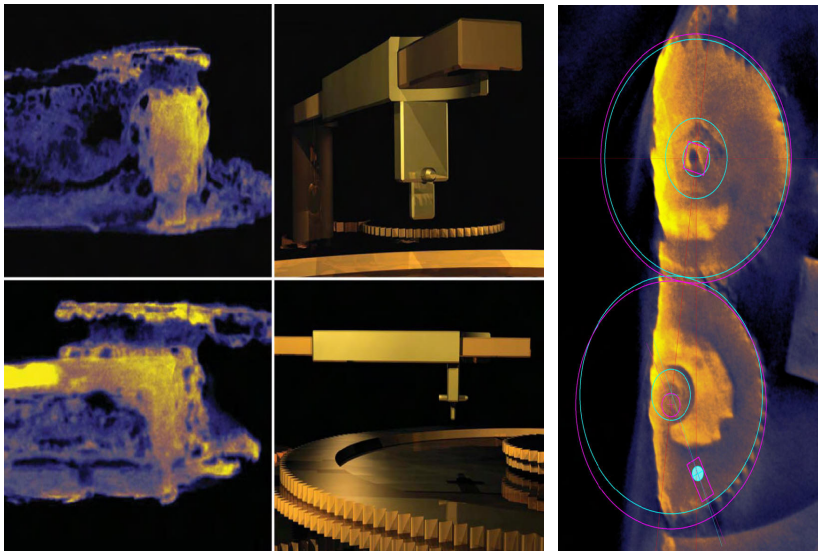

# THE ANTIKYTHERA MECHANISM ANALYSIS

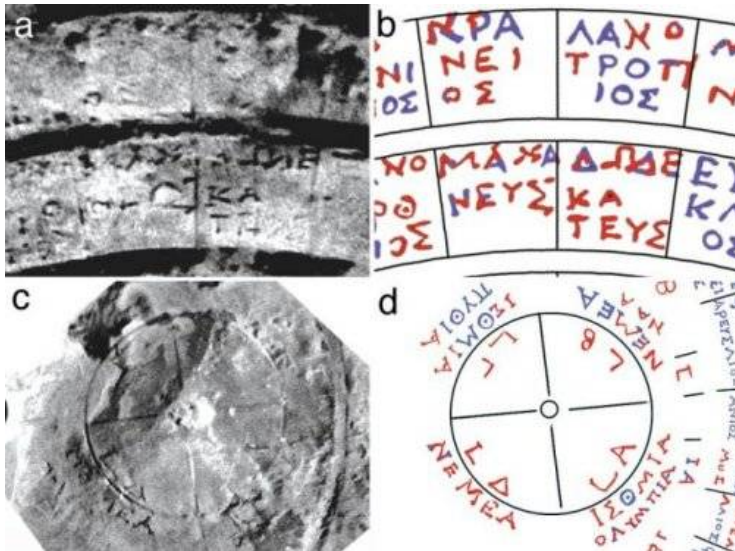

# THE ANTIKYTHERA MECHANISM – CURRENT STATUS

**THE ANTIKYTHERA MECHANISM** - complex ancient mechanical device designed to predict astronomical phenomena and keep track of the cycles in the Solar System.

Main facts:

1. recovered by sponge divers on 17 May 1902 from a wreck near the island of Antikythera
2. time of construction - 150-100 BC (current estimate)
3. made in Greek speaking world - words written in Koine Greek (300 BC – 300 AD)
4. mechanical sophistication - comparable to 19th century Swiss clocks !
5. complexity and workmanship - comparable to 14th century !

# THE MECHANISM OVERVIEW

Main features:

1. 37 bronze gears – new studies  
72 gears
2. estimated size (cm): 33 x 17 x 9
3. current date entered by a crank
4. geocentric model
5. 3 dials
  - **Sun and Moon**
  - 5 known **planets** (?)
7. upper back dial
  - **Metonic cycle**
  - **Callippic cycle**
  - **Olimpiad cycle**
8. lower back dial
  - **Soros cycle**
  - **Exeligmos cycle**

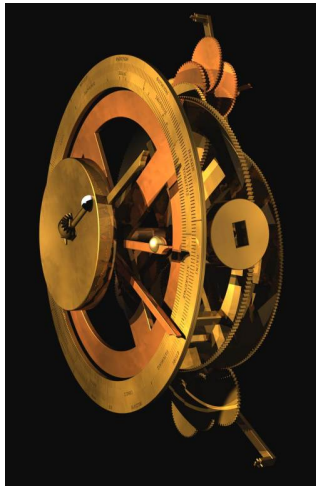

# THE FRONT DIAL

## Overview:

1. outer scale – Egyptian calendar with 365 days (12m x 30d + 5d)
2. inner scale – Greek signs of the Zodiac divided into degrees
3. leap year compensation: rotational outer scale
4. 3 hands: Sun (counterclockwise), Moon (clockwise), date (input)
5. planets – hypothetically
  - the words 'Mars' and 'Venus' were found
  - unnecessarily large wheel for the Sun
6. Moon hand
  - black and white sphere displays lunar phase
  - additional mechanism – anomaly of the Moon's orbit

## FONT DIAL



# ANOMALY OF THE MOON

## Overview:

1. caused by elliptic orbit
2. additional gears introduced to include the anomaly
3. *eccentric* = *epicyclic*
4. distances chosen to match Hipparchus's values
5. Moon: eccentric hypothesis – nonconcentric gear connection
6. Sun: epicyclic hypothesis – gears attached to the edge of the Sun's wheel
  - Sun epicyclic gearing not found
7. planets – epicyclic gear train similar to Sun's gearing

## ECCENTRIC GEARING

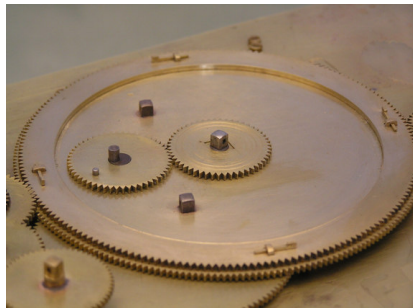

# THE BACK DIALS

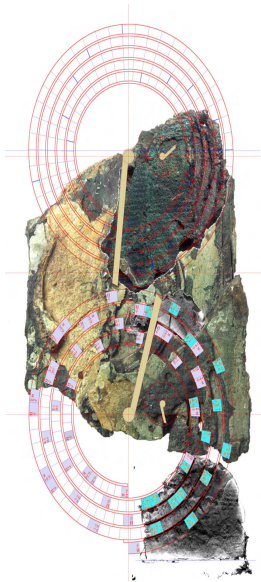

# THE BACK DIALS I

Lower back dial:

1. spiral scale with 223 divisions per 4 hand turns – **SAROS CYCLE**

$223 \text{ synodic months} \approx 6585 \frac{1}{3} \text{ days}$

(almost) eclipse cycle

2. eclipses marked on the scale
3. movable tongue showed which turn of the scale to read
4. smaller dial showed the **EXELIGMOS CYCLE**  
 $= 3 \times \text{Saros (54 years)}$  – allows further adjustment

## THE BACK DIALS

The rear of the Antikythera mechanism might have looked something like this

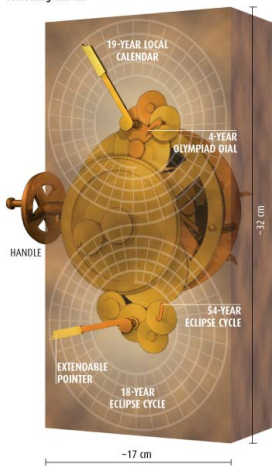

# THE BACK DIALS II

Upper back dial:

1. spiral scale with 47 divisions per hand turn
2. 5 hand turns = a cycle
3.  $5 \times 47 = 235$  – **METONIC CYCLE** (432 BC)

$235$  synodic months  $\approx 19$  julian years  $\approx 6940$  days

4. one small dial – 4 year **OLIMPIAD CYCLE** – discovered recently by AMRP
5. second small dial – 4 divisions – **CALLIPPIC CYCLE** (330 BC)

$4 \times$  Metonic cycle = 76 julian years  $\approx 940$  synodic months

purpose:

- improves the approximation in the Metonic cycle
- allows to compare distant dates

# SUN-MOON ACCURACY

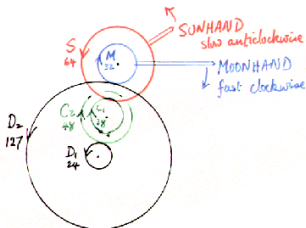
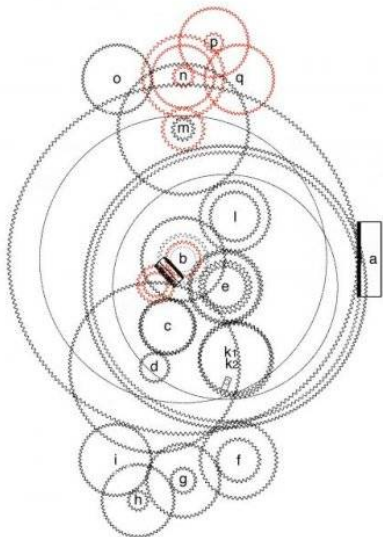

Moonwheel  $M$  drives  $D_2$  fixed to  $D_1$   
 $D_1$  drives  $C_2$  fixed to  $C_1$   
 $C_1$  drives  $S$  sunwheel.

$$\begin{aligned} \text{Gear ratio} &= \frac{S}{C_1} \times \frac{C_2}{D_1} \times \frac{D_2}{M} \\ &= \frac{64}{38} \times \frac{48}{24} \times \frac{127}{32} \\ &= \frac{254}{19} \\ &= 13.3684 \dots \end{aligned}$$

(compare with modern figure 13.3687...)  
 $= \mu$ , correct to 1 in 40,000.

$$19 \text{ yrs} = 235 \text{ mo} \therefore \lambda = \mu - 1 = \frac{235}{19} \quad \text{(Melon, 11th June 431 BC)}$$

How did the Greeks achieve such accuracy?

# ORIGINS

The constructors:

1. **HIPPARCHUS** (c. 190 BC – c. 120 BC) and the Academy of Posidonius on Rhodos – center of astronomy and mechanical engineering in Ancient Greece
2. **ARCHIMEDES** (c. 287 BC – c. 212 BC) and his pupils in the colonies of Corinth

The ship

1. circumstances under which the mechanism came to be on the cargo ship are unknown
2. suggestions: ship traveling to Rome with treasures looted from the island to support a triumphal parade being staged by Julius Caesar



**Thank you!**